



Room thermostat with Auto Timer, independent DHW RDE100.1 DHW

for heating systems

- Room temperature control
- 2-position / TPI control with On/Off output for heating
- Optimum Start / Stop
- Comfort, Economy, Auto timer and Protection mode
- Independent On/Auto/Off control of DHW
- Auto time switch
- Adjustable commissioning and control parameters
- Battery-powered DC 3 V (2 x 1.5 V AAA)

Use

The RDE100.1DHW is used to control the room temperature in heating systems with independent control of DHW.

Typical applications:

- Residential apartments

For the control of the following plant components and of DHW:

- Thermal valves or zone valves
- Gas or oil boilers
- Fans
- Pumps
- Heat exchanger
- Continuous-flow water heater
- Small water heating systems

Functions

- Room temperature control via built-in sensor
- Selection of operating mode with operating mode touchkey
- Setting auto time switch (individual day, 7 day or 5-2 day)
- Display of current room temperature or setpoint in °C or °F
- Touchkey lock (manually)
- Setpoint lock
- Periodic pump run
- Optimum start / stop
- Comfort temperature limitation by Economy setpoint locked
- Reloading factory settings for commissioning and control parameters
- Independent DHW and its auto time switch (individual day, 7 day or 5-2 day)

Temperature control

RDE100.. comprises of both 2-position and TPI temperature controls, which can be configured by parameter P78 (Control Behavior).

2-position control algorithm is to switch on and off the heating system within a switching differential according to comparison between setpoint setting and the measured room temperature.

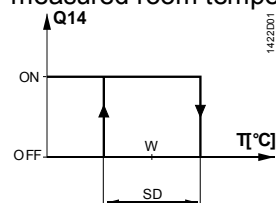

- T Room temperature
- SD Switching differential
- W Room temperature setpoint
- Q14 Output signal for heating

TPI (Time proportional Integral) control algorithm is to periodically switch on and off the heating system. The period time and pulse length of the control signal (PWM) are determined by the setpoint and the measured room temperature.

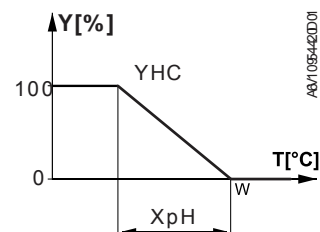

- Heating mode
- T Room temperature
- Y Output signal for heating (PWM)
- W Room temperature setpoint
- YHC Control command "Valve"
- XpH Proportional band "Heating"

Periodic pump run function

Can only be used when circulating pump or valve is controlled!

This function protects the pump or valve against seizing during longer off periods. Periodic pump run is activated for 3 minutes every 24 hours at 12:00.

Parameter	Pump status
P12 = 0 (Default)	Pump run off
P12 = 1	Pump run on

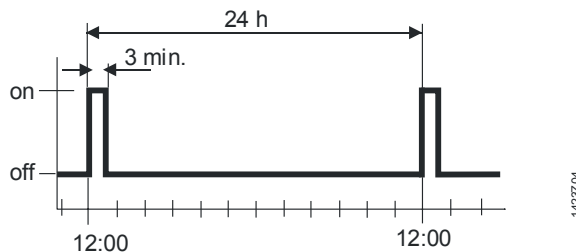

Optimum start control

The purpose of optimum start control is to reach a temperature level 0.25 K below the Comfort setpoint when occupancy according to the time program starts in Auto timer mode. For that purpose, the heating circuit must be switched on at an earlier point in time. The extent of forward shift depends primarily on the outside temperature.

The maximum forward shift on time can be adjusted by parameter P89. A Forward shift on maximum "0" means the function is disabled.

Parameter	Range	Factory setting
Forward shift on max (P89)	0, 0.5,...24 h	0

Optimum stop control

Optimum stop control switches off the heating circuit at the earliest possible point in time so that the room temperature will lay 0.5 K below the Comfort setpoint when the time switch changes from Comfort mode to Economy mode in Auto timer mode. The early shut down maximum time can be adjusted by parameter P90. Early shut down maximum "0" means the function is disabled.

Parameter	Range	Factory setting
Early shutdown max (P90)	0, 0.5,...6 h	0

Control behavior (P78)

2-position, 1 K

2-Position controller with 1 [K] switching hysteresis

2-position, 0.3 K

- 2-Position controller with 0.3 [K] switching hysteresis.
- For general control situations. Provides a better comfort than 1 [K] switching hysteresis.
- Can also be used for difficult control situations.

TPI slow

TPI control behavior for slow heating systems that require longer minimum On times and limited numbers of switching cycles per hour.

Typical applications:

- Floor heating systems, oil fired boilers
- Can also be used for all other types of heating applications. (Alternative setting)

Minimum switching on / off time	> 4 minutes
Average period time	Approximately 20 minutes

TPI medium

TPI control behavior for general heating applications such as radiator systems, thermal actuators, ...

Minimum switching on / off time	> 1 minute
Average period time	Approximately 20-25 minutes

TPI fast

TPI control behavior for fast heating systems that tolerate a high number of switching cycles.

Typical applications: electric heaters, gas boilers, fast thermal actuators

Minimum switching on / off time	> 1 minute
Average period time	Approximately 10 minutes

 Do not use TPI fast for oil boilers or electro mechanical actuators!

Type summary

Product No.	Stock No.	Features
RDE100.1DHW	S55770-T280	Battery-powered DC 3 V









Ordering

- When ordering, please indicate product No. / stock No. and description.
- Example:

Product No.	Stock No.	Description
RDE100.1DHW	S55770-T280	DHW room thermostat

Valve actuators must be ordered separately!

Equipment combinations

Description		Product No.	Data Sheet *)	Use with the type of Temperature Control
Electromotoric actuator		SFA21..	4863	2-Position & TPI slow
Electrothermal actuator (for radiator valves)		STA23..	4884	2-Position & All TPI
Electrothermal actuator (for small valves 2.5 mm)		STP23..	4884	2-Position & All TPI
Electromotoric actuator for zone valves VVI46..		SUA21..	4830	2-Position
Damper actuator		GDB..	4634	2-Position & TPI slow
Damper actuator		GSD..	4603	2-Position & TPI slow
Damper actuator		GQD..	4604	2-Position & TPI slow
Rotary damper actuator		GXD..	4622	2-Position & TPI slow

*) The documents can be downloaded from <http://siemens.com/bt/download>.

Mechanical design

The room thermostat consists of 2 parts:

- Plastic housing which accommodates the electronics, the operating elements and the room temperature sensor
- Mounting plate with screw terminals

The housing engages in the mounting plate and is secured with a screw.

Operation and settings

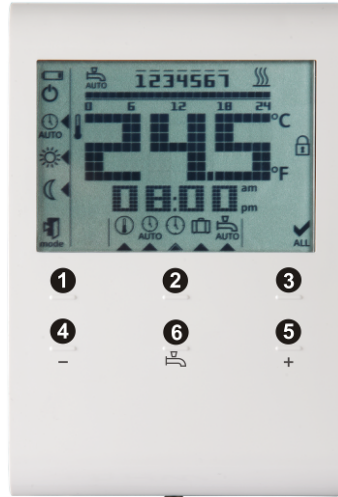





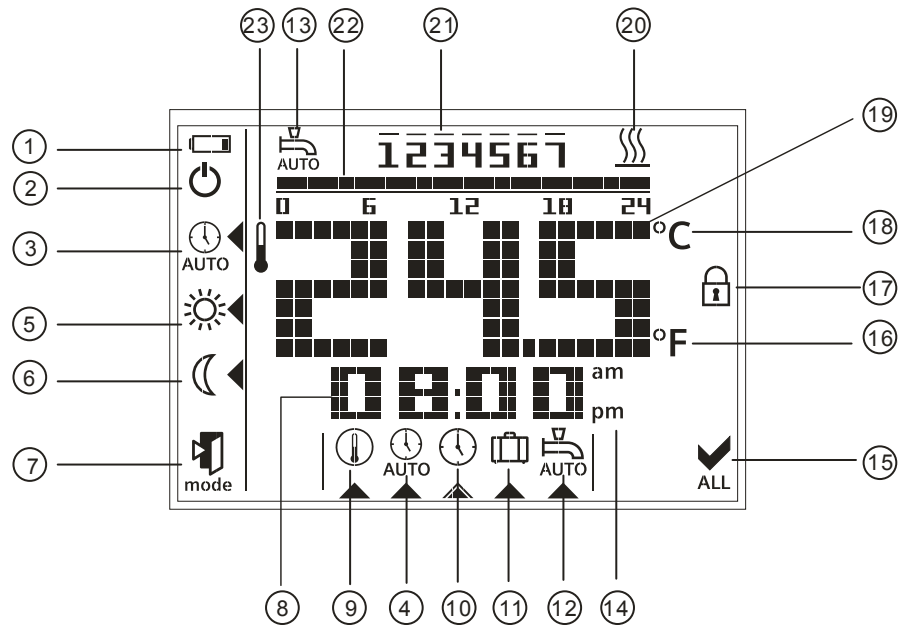





- 1) Operating mode touchkey
- 2) Set
- 3) Ok
- 4) Touchkey for decreasing a value
- 5) Touchkey for increasing a value
- 6) DHW switch On/Auto/Off touchkey

Display



#	Symbol	Description	#	Symbol	Description
1		Indicating that batteries need to be replaced	12		View and set DHW auto time switch
2		Protection mode (protection mode symbol can be enabled via parameter settings).	13		DHW auto time switch activated
3		Auto timer mode	14	am pm	Morning: 12-hour format Afternoon: 12-hour format
4		View and set auto time switch	15		Confirmation
5		Comfort mode	16	°F	Room temperature in degrees Fahrenheit
6		Economy mode	17		Touchkey lock activated

#	Symbol	Description	#	Symbol	Description
7	 mode	Escape	18	°C	Room temperature in degrees Celsius
8		Display of time	19		Display of room temperature, setpoint, and etc.
9		Permanent setpoint setting	20		Heating On
10		Day and time setting	21		Weekday 1 = Monday 7 = Sunday
11		Holiday mode setting	22		Timer bar (Alternative use as DHW timer bar)
			23		Current room temperature

Mounting and installation notes

Do not mount the thermostat in niches or bookshelves, not behind curtains, not above or near heat sources, and not exposed to direct solar radiation. Mount about 1.5 m above the floor.

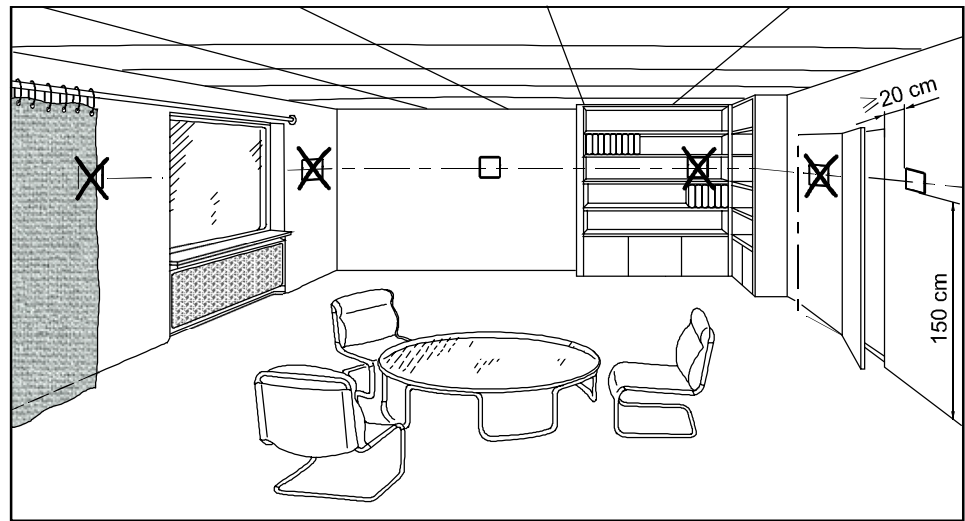

Mounting



- Mount the thermostat in a clean and dry location without direct air flow from a heating/cooling equipment, and not exposed to drip or splash water
See the Mounting Instructions M1429 enclosed with the thermostat.

Wiring



- Ensure that wiring, protection and earthing comply with local regulations
- Correctly size the cables to the thermostat and the valve actuators
- Use only valve actuators rated for AC 24...230 V

Warning!

No internal line protection for supply lines to external consumers.

Risk of fire and injury due to short-circuits!











- Adapt the line diameters as per local regulations to the rated value of the installed overcurrent protection device.
- The AC 230 V mains supply line must have a circuit breaker with a rated current of no more than 10 A
- Disconnect from power supply before removing the unit from its mounting plate

Commissioning notes

Commissioning	<p>After power is applied, the thermostat carries out a reset during which all LCD segments flash, indicating that the reset was made correctly. After the reset, the thermostat is ready for commissioning by qualified HVAC personnel.</p> <p>The control parameters of the thermostat can be set to ensure optimum performance of the entire system. Please refer to Operating Instructions CB1B1423, section "Do you want to change parameters?".</p>
Sensor calibration	<p>If the temperature on the display does not agree with the room temperature effectively measured, the temperature sensor can be recalibrated. For that purpose, adjust parameter P04.</p>
Setpoint lock	<p>We recommend reviewing the setpoint lock (for public areas) in parameters P06 and P08 and changing them as needed. If the Economy setpoint is locked then the Comfort temperature setpoint can not be set lower than the locked Economy setpoint.</p>
Touchpad scanning rate	<p>Since the thermostat uses touch technology and to minimize battery power consumption, a parameter P21 (adjustable from 0.25 to 1.5 seconds) is implemented for the user to adjust. This function is only valid for the battery-powered version and the default value is 1 second.</p> <p>This means that when, for a certain time, the user does not touch the touchpad, the unit operates in power saving mode and the touchpad is running at a scanning rate of 1 second.</p> <p>(From the calculation – assuming 4 operations per day on the thermostat, the estimated 1-second scanning rate results in a battery life of 1 year. If the user increases the scanning rate, the batteries' life is extended.)</p>
Change of batteries	<p>If the battery symbol  appears, the batteries are almost exhausted and should be replaced. Use alkaline batteries type AAA.</p>

Operating notes

	<p>The RDE100.1DHW provides Comfort, Economy, Auto timer and Protection mode. The difference between Comfort and Economy mode is only the room temperature setpoint. The changeover between Comfort, Economy and Protection mode is made either automatically by the auto time switch or by pressing touchkey mode.</p>
Comfort mode 	<p>When Comfort mode is activated, symbol  appears on the display. The setpoint (20 °C) can be readjusted by pressing touchkeys + and –.</p>
Economy mode 	<p>When Economy mode is activated, symbol  appears on the display. The setpoint (16 °C) can be readjusted by pressing touchkeys + and –.</p>
Protection mode 	<p>If the temperature falls below 5 °C, the unit automatically activates the heating output. The symbol  appears only, if the icon is enabled via parameter settings.</p>
Holiday mode 	<p>When holiday mode is activated, symbol  appears on the display. The setpoint (12 °C) and the number of days a user is away can be readjusted by pressing touchkeys + and –.</p>

Time switch





When Auto timer mode is enabled, the changeover between the operating modes (Comfort and Economy mode) will take place automatically. There are three options for time switch setting: individual day, 7 day or 5-2 day. You can select Comfort or Economy mode in every 15 minutes interval of the day. The 0:00 to 24:00 hour time bar will allow you to set the mode throughout the selected day(s).

Factory default for 7-day Time switch

Default value	Day/s	Comfort mode	Economy mode
	Mo (1) – Fr (5)	6:00 – 8:00 hr	22:00 – 6:00 hr
		17:00 – 22:00 hr	8:00 – 17:00 hr
	Sa (6) – Su (7)	7:00 – 22:00 hr	22:00 – 7:00 hr

Please refer to Operating Instructions CB1B1423, section "Do you want to enter your own Time switch?".

DHW and DHW auto timer function

Press  to switch on DHW heating. Press this  touchkey again, DHW will be in the auto status, this  symbol will be shown. Press this  touchkey one more time, DHW heating will be switched off and no symbol will be shown.

Please refer to Operating Instructions CB1B1423, section "Do you want to activate DHW control?".

During auto status, the DHW will switch according to the DHW time switch set. DHW can be selected on or off in every 15 minutes interval of the day. The 0:00 to 24:00 hour time bar will allow you to set DHW on or off throughout the selected day(s).

Factory default for 7-day Time switch for DHW

Default value	Day/s	DHW control ON	DHW control OFF
	Mo (1) – Fr (5)	6:00 – 8:00 hr	22:00 – 6:00 hr
		17:00 – 22:00 hr	8:00 – 17:00 hr
	Sa (6) – Su (7)	7:00 – 22:00 hr	22:00 – 7:00 hr

Please refer to Operating Instructions CB1B1423, section "Do you want to enter your own Time switch for DHW control?".

Parameters

Changing the parameters by the following steps:

- Press **+** and **-** simultaneously for 5 seconds
- Release them and parameter "P01" is displayed on the bottom segment
- Press **+** or **-** to scroll to the parameter that needs to be adjusted
- Press **ok** to select this parameter
- Press **+** or **-** to adjust the value
- Press **ok** to confirm the adjusted value
- Press mode to exit the parameters without saving or wait for the program to exit automatically

Parameter list

Parameter no.	Description	Setting range (default)
P01	Time format	1 = 24:00 hours (default) 2 = 12:00 AM/PM
P02	Selection of °C or °F	1 = °C (default) 2 = °F
P03	Standard temperature display	1 = room temperature (default) 2 = setpoint

P04	Temperature sensor calibration	-3...3 °C Step 0.5 °C (-6...6 °F, step 1 °F) Default: 0 °C
P06	Comfort setpoint lock	0 = OFF (default) 1 = ON → locked according to setting in permanent temperature setpoint
P08	Economy setpoint lock	0 = OFF (default) 1 = ON → locked according to setting in permanent temperature setpoint
P09	Buzzer	0 = OFF 1 = ON (default)
P10	Show frost protection icon	0 = OFF (default) 1 = ON
P11	Time switch type for auto timer and DHW	0 = Individual Days (default) 1 = All 7 days 2 = 5/2 days
P12	Periodic pump run	0 = OFF (default) 1 = ON
P13	DHW timer bar timeout	0 = no DHW bar 1 = 1 minute (default) 2 = 2 minutes Adjustable range 0 to 15 minutes
P21	Button scanning rate for the capacitive buttons Note: a higher scanning rate means shorter battery life.	0.2 = 0.25 s 0.5 = 0.5 s 1.0 = 1.0 s (default) 1.5 = 1.5 s
P22	Reload factory settings	0 = OFF (default) 1 = reload
P23	Software version information	No adjustment possible
P78	Control behavior	0 = On/Off, 1.0 K 1 = On/Off, 0.3 K 2 = TPI fast 3 = TPI medium 4 = TPI slow (default)
P89	Forward shift on max	0, 0.5,...24 h Default: 0 h
P90	Early shutdown max	0, 0.5,...6 h Default: 0 h

Maintenance notes

The thermostats are maintenance-free.

Disposal



The device is considered an electronic device for disposal in terms of the European Directive 2012/19/EU and may not be disposed of as domestic garbage.



- Dispose of the device through channels provided for this purpose.
- Comply with all local and currently applicable laws and regulations.
- Dispose of empty batteries in designated collection points.

		WARNING
	<p>Risk of explosion due to fire or short-circuit, even if the batteries are empty Risk of injuries from by flying parts</p> <ul style="list-style-type: none"> • Do not allow the batteries to come into contact with water. • Do not charge the batteries. • Do not damage or destroy the batteries. • Do not heat the batteries to more than 85 °C. 	
		WARNING
	<p>Electrolyte leakage Chemical burns</p> <ul style="list-style-type: none"> • Only grasp damaged batteries using suitable protective gloves. • If electrolyte comes into contact with eyes, immediately rinse eyes with plenty of water. Consult a doctor. 	

Observe the following:

- Only replace batteries with batteries of the same type and from the same manufacturer.
- Observe the polarities (+/-).
- The batteries must be new and free from damage.
- Do not mixed new batteries with used batteries.
- Store, transport, and dispose of the batteries in accordance with local regulations, guidelines, and laws. Also observe information from the battery manufacturer.

Technical data

 Power supply	Operating voltage		DC 3 V (2 x 1.5 V alkaline batteries AAA)	
	<ul style="list-style-type: none"> RDE100.1DHW 			
	For battery life (RDE100.1DHW), see below (alkaline batteries type AAA). Battery life calculation is based on the touchpad scanning rate during idle time (assuming a user presses 4 touchkeys per day with default TPI Slow control):			
	Scanning rate 0.25 s	0.7 year battery life		
	Scanning rate 0.50 s	1.0 year battery life		
Scanning rate 1.00 s	1.2 year battery life			
Scanning rate 1.50 s	1.3 year battery life			
Control inputs	Control input Q11-Nx (Com)	(AC 24...230 V)	Max. 5(2) A	Min. 8 mA
	Control input Q21-Nx (Com)	(AC 24...230 V)	Max. 5(2) A	Min. 8 mA
Control outputs	Heating valve or wall-hung boiler			
	Control output Q12-Nx (NC contact)	(AC 24...230 V)	Max. 5(2) A	Min. 8 mA
	Control output Q14-Nx (NO contact)	(AC 24...230 V)	Max. 5(2) A	Min. 8 mA
	DHW heating equipment			
	Control output Q22-Nx (NC contact)	(AC 24...230 V)	Max. 5(2) A	Min. 8 mA
	Control output Q24-Nx (NO contact)	(AC 24...230 V)	Max. 5(2) A	Min. 8 mA
	No internal fuse.			
	External preliminary protection with max. C 10 A circuit breaker in the supply lines required under all circumstances.			
	External protection for incoming cable			
	Circuit breaker	Max. 10 A		
Function data	Circuit breaker tripping characteristic	Type B, C or D to EN 60898 and EN 60947		
	Comfort mode	20 °C (5...35 °C)		
	Economy mode	16 °C (5...35 °C)		
	Holiday mode	12 °C (5...35 °C) (Standalone)		
	Built-in room temperature sensor			
	Setpoint setting range	5...35 °C (Comfort/Economy mode)		
	Accuracy at 25 °C	< ±0.5 K		
	Temperature calibration range	±3.0 K		
	Resolution of settings and displays			
	Setpoints	0.5 °C		
Temperature value displays	0.5 °C			
Environmental conditions	Operation			
	Climatic conditions	Class 3K5		
	Temperature	0...50 °C		
	Humidity	<95% r.h.		
	Transport			
	Climatic conditions	Class 2K3		
	Temperature	-25...65 °C		
	Humidity	<95% r.h.		
	Mechanical conditions	Class 2M2		
	Storage			
	Climatic conditions	Class 1K3		
	Temperature	-25...65 °C		
	Humidity	<95% r.h.		

Norms and standards	EU Conformity (CE)	A6V11399487 ^{*)}
	RCM conformity	A6V11399489 ^{*)}
	Safety class	II as per EN 60730-1, EN 60730-2-9
	Pollution class	II as per EN 60730-1
	Degree of protection of housing	IP30 as per EN 60529
Environmental compatibility	The product environmental declaration CE1E1420xx ^{*)} contains data on environmentally compatible product design and assessments (RoHS compliance, materials composition, packaging, environmental benefit, disposal).	
Eco design and labelling directives	Based on EU Regulation 813/2013 (Eco design directive) and 811/2013 (Labelling directive) concerning space heaters, combination heaters, the following classes apply: <ul style="list-style-type: none"> - Application with On/Off operation of a heater Class I value 1% - TPI (PWM) room thermostat, for use with On/Off output heaters Class IV value 2% 	
General	Connection terminals for	Solid wires or prepared stranded wires 2 x 1.5 mm ² or 1 x 2.5 mm ² (Min. 0.5 mm ²)
	Weight	0.167 kg
	Color of housing front	RAL9003

*) The documents can be downloaded from <http://siemens.com/bt/download>.

Connection diagrams

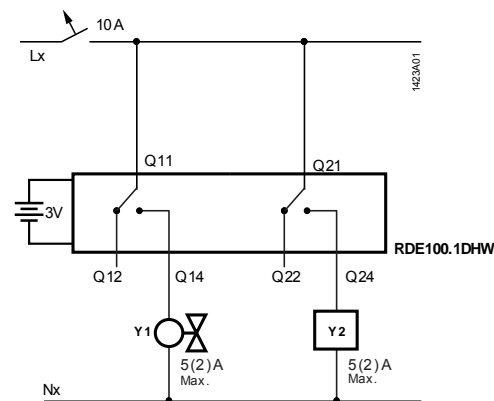

Legend

Lx	Live, AC 24...230 V
Nx	Neutral conductor, AC 24...230 V
Y1	Heating valve or wall-hung boiler
Y2	DHW heating equipment

Application examples

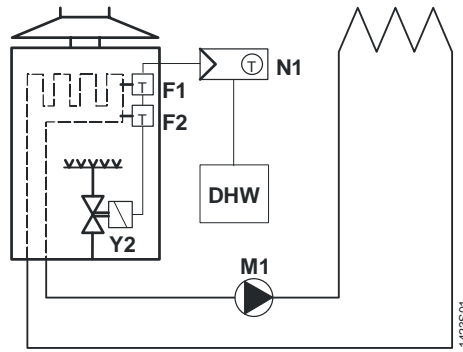

Room thermostat with direct control of a gas-fired wall-hung boiler and independent control of DHW

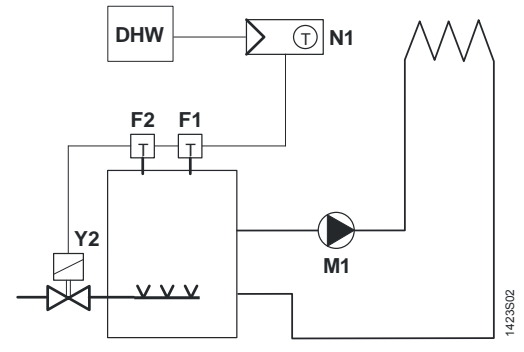

Room thermostat with direct control of a gas-fired floor-standing boiler and independent control of DHW

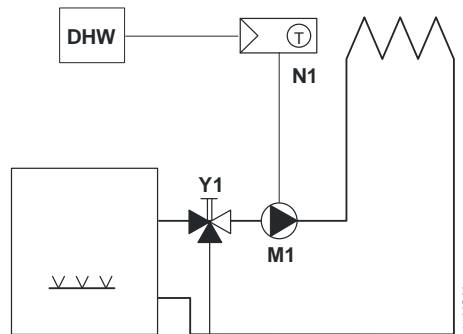

Room thermostat with direct control of a heating circuit pump (precontrol by manual mixing valve) and independent control of DHW

Legend

- F1 Thermal reset limit thermostat
- F2 Safety limit thermostat
- M1 Circulating pump
- N1 RDE100.1DHW room thermostat
- Y1 Mixing 3-port valve with manual adjustment
- Y2 DHW magnetic valve
- DHW DHW heating equipment

Dimensions

All dimensions in mm

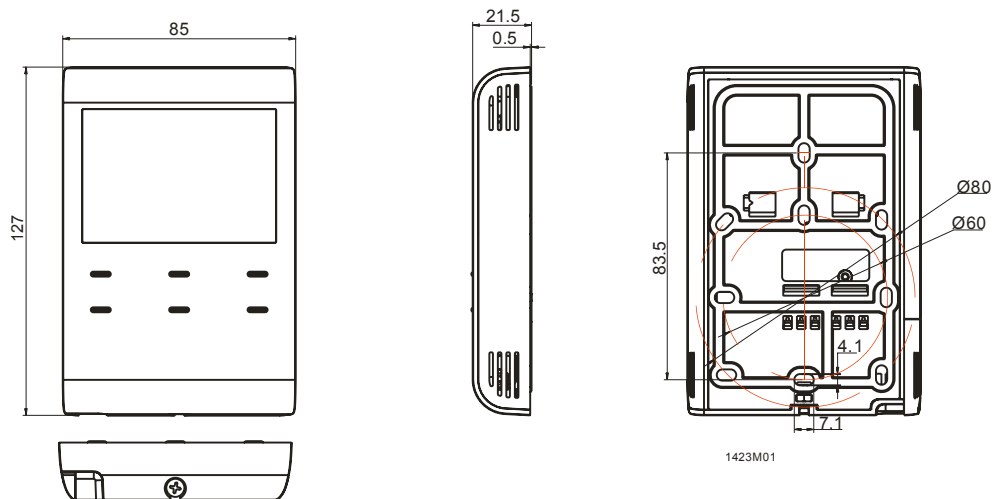

Remarks

Heating:

Because of the unavoidable self heating effects of the electrical current, any loads of more than 3 Amperes connected to the unit can influence the control behavior and temperature accuracy in a negative way.

Issued by
Siemens Switzerland Ltd
Building Technologies Division
International Headquarters
Theilerstrasse 1a
CH-6300 Zug
Tel. +41 58 724 2424
www.siemens.com/buildingtechnologies

© Siemens Switzerland Ltd., 2017
Technical specifications and availability subject to change without notice.